

THIS DOCUMENT AND THE INFORMATION CONTAINED IN IT ARE PROPRIETARY AND CONFIDENTIAL TO **MELLANOX TECHNOLOGIES LTD.** LIMITED. NO PERSON IS ALLOWED TO COPY, REPRINT, REPRODUCE OR PUBLISH ANY PART OF THIS DOCUMENT, NOR DISCLOSE ITS CONTENTS TO OTHERS, NOR MAKE ANY USE OF IT, NOR ALLOW OR ASSIST OTHERS TO MAKE ANY USE OF IT - UNLESS BY THE PRIOR WRITTEN EXPRESS AUTHORIZATION OF **MELLANOX TECHNOLOGIES LTD.** AND THEN ONLY TO THE EXTENT AUTHORIZED.
(C) COPYRIGHT - **MELLANOX TECHNOLOGIES LTD.**

REV	DESCRIPTION	DATE
00	RELEASED PER ECO-015680	7-NOV-2013

NOTES:

1. REF DOC19588 ENVIRONMENTAL REQUIREMENTS FOR SUPPLIERS.
2. ENVIRONMENTAL: ALL MATERIALS AND SURFACE FINISHES COMPLY WITH RoHS DIRECTIVE 2002/95/EC.
3. AIR FLOWS ORIENTED TO THE HEAT SINK FINNS.

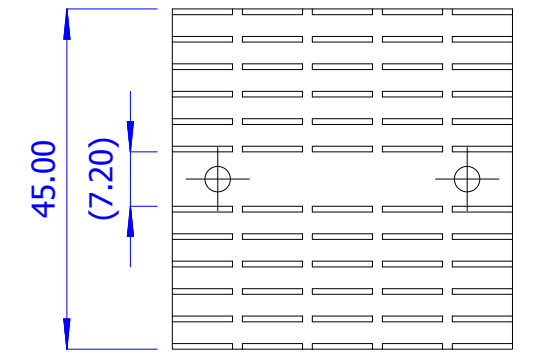
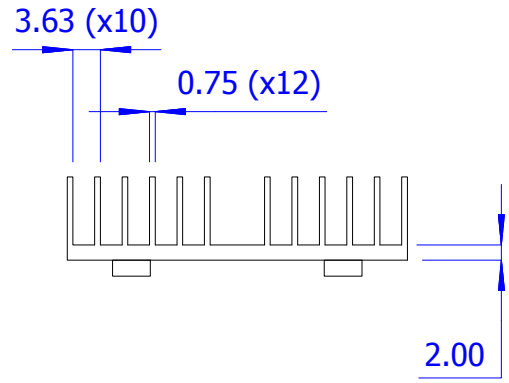
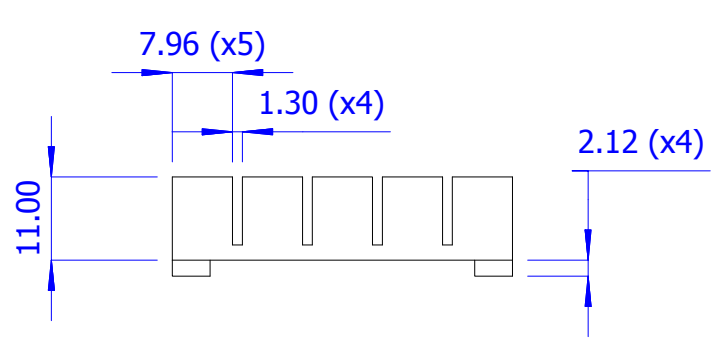
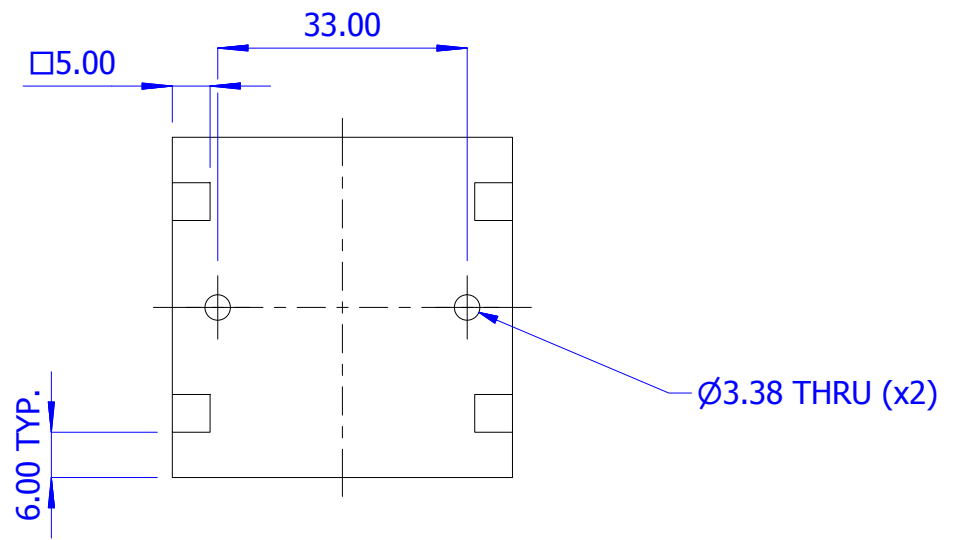

→
**AIR FLOW DIRECTION
(SEE NOTE #3)**

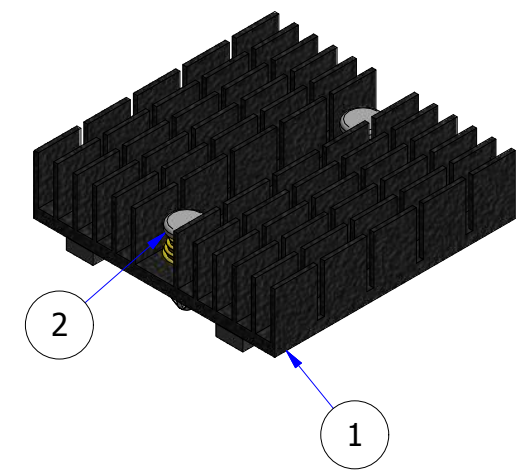
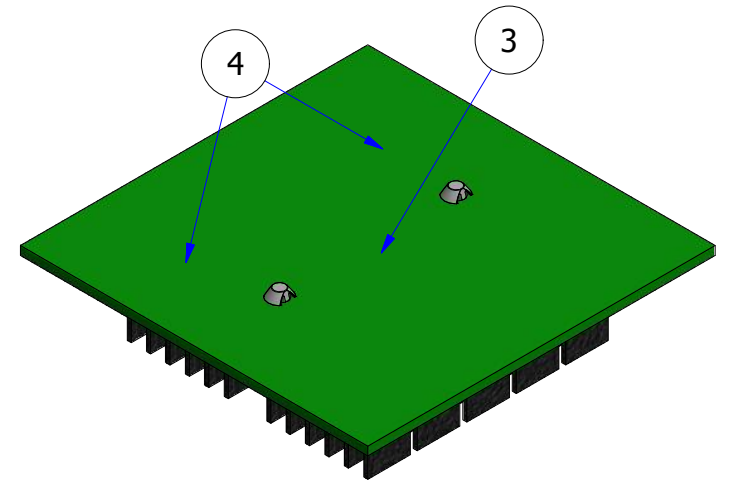

ITEM	QTY	DESCRIPTION
1	1	HEAT SINK
2	2	PUSH PIN AND SPRING
3		GREASE
4	4	BUMPERS

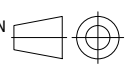
UNLESS OTHERWISE SPECIFIED DIMENSIONS ARE IN MM		Mellanox Technologies Ltd. P.O.B. 586 Yokneam Zip : 20692 - Israel Tel : 972-4-9097200		
USE DIMENSIONS ONLY DO NOT SCALE		TITLE		
GENERAL TOLERANCE:		1st ANGLE PROJECTION 	Heat sink for ConnectX®-3 Pro with thermal grease with 2 push-pins	
LINEAR:	± 0.1		SCALE	SIZE
RADIAL:	± 0.1			DRAWING / P.N. :
ANGLES:	± 0.5°			MTMH00061
BTWN HOLE CENTERS:	± 0.1			REV
				00

8 7 6 5 4 3 2 1

F
E
D
C
B
A

THIS DOCUMENT AND THE INFORMATION CONTAINED IN IT ARE PROPRIETARY AND CONFIDENTIAL TO **MELLANOX TECHNOLOGIES LTD.** LIMITED. NO PERSON IS ALLOWED TO COPY, REPRINT, REPRODUCE OR PUBLISH ANY PART OF THIS DOCUMENT, NOR DISCLOSE ITS CONTENTS TO OTHERS, NOR MAKE ANY USE OF IT, NOR ALLOW OR ASSIST OTHERS TO MAKE ANY USE OF IT - UNLESS BY THE PRIOR WRITTEN EXPRESS AUTHORIZATION OF **MELLANOX TECHNOLOGIES LTD.** AND THEN ONLY TO THE EXTENT AUTHORIZED.
(C) COPYRIGHT - **MELLANOX TECHNOLOGIES LTD.** .

RECOMMENDED FOOTPRINT

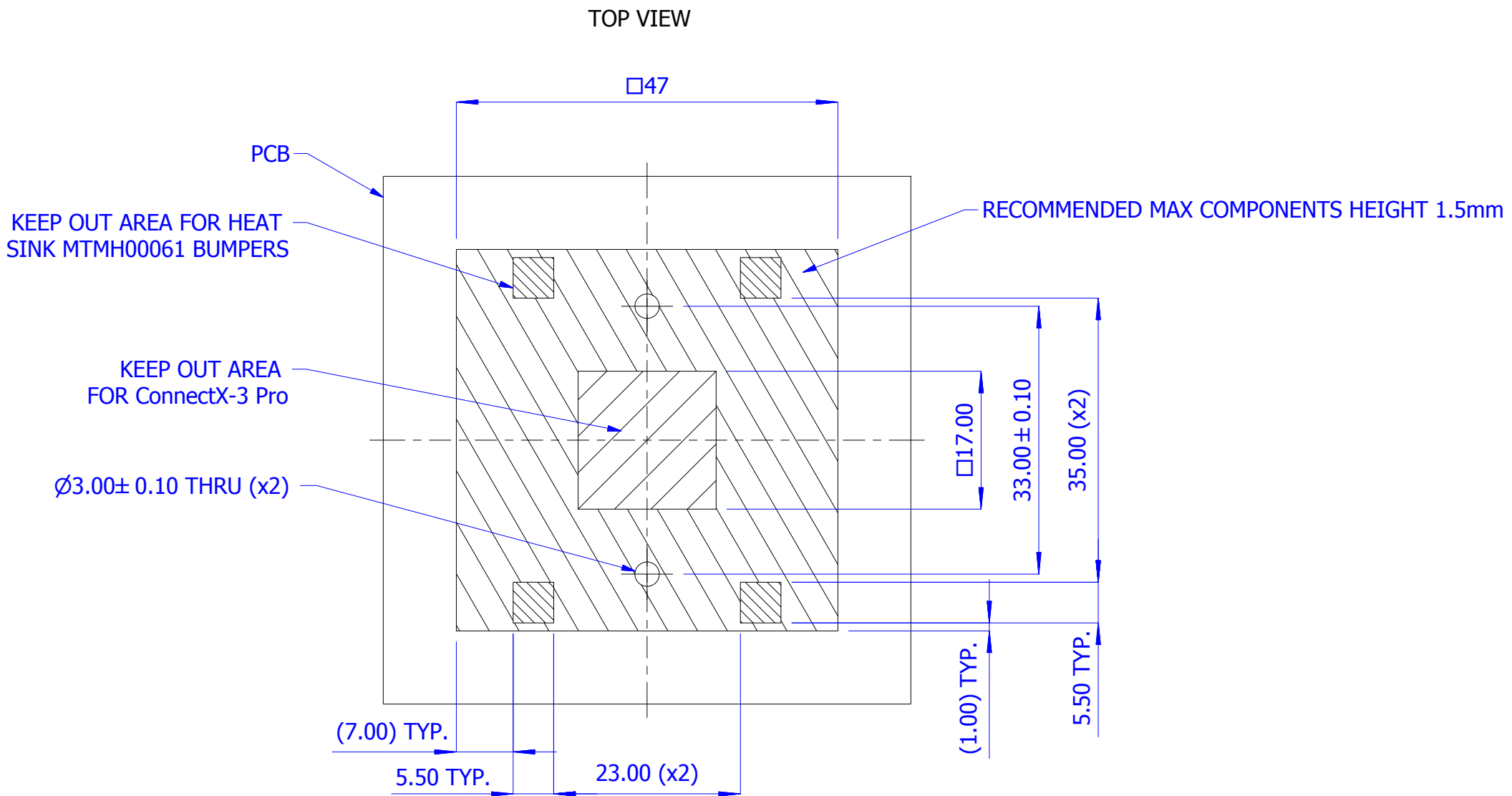

UNLESS OTHERWISE SPECIFIED DIMENSIONS ARE IN MM		Mellanox Technologies Ltd. P.O.B. 586 Yokneam Zip : 20692 - Israel Tel : 972-4-9097200			
USE DIMENSIONS ONLY DO NOT SCALE		TITLE		Heat sink for ConnectX®-3 Pro with thermal grease with 2 push-pins	
GENERAL TOLERANCE:		1st ANGLE PROJECTION		SCALE	
LINER:	± 0.1	SIZE		DRAWING / P.N. :	
RADIAL:	± 0.1	A3		MTMH00061	
ANGLES:	± 0.5°	REV		00	
BTWN HOLE CENTERS:	± 0.1	SHEET 2 OF 3			

8 7 6 5 4 3 2 1

F
E
D
C
B
A

THIS DOCUMENT AND THE INFORMATION CONTAINED IN IT ARE PROPRIETARY AND CONFIDENTIAL TO MELLANOX TECHNOLOGIES LTD. LIMITED. NO PERSON IS ALLOWED TO COPY, REPRINT, REPRODUCE OR PUBLISH ANY PART OF THIS DOCUMENT, NOR DISCLOSE ITS CONTENTS TO OTHERS, NOR MAKE ANY USE OF IT, NOR ALLOW OR ASSIST OTHERS TO MAKE ANY USE OF IT - UNLESS BY THE PRIOR WRITTEN EXPRESS AUTHORIZATION OF MELLANOX TECHNOLOGIES LTD. AND THEN ONLY TO THE EXTENT AUTHORIZED.
(C) COPYRIGHT - MELLANOX TECHNOLOGIES LTD. .

SECTION VIEW

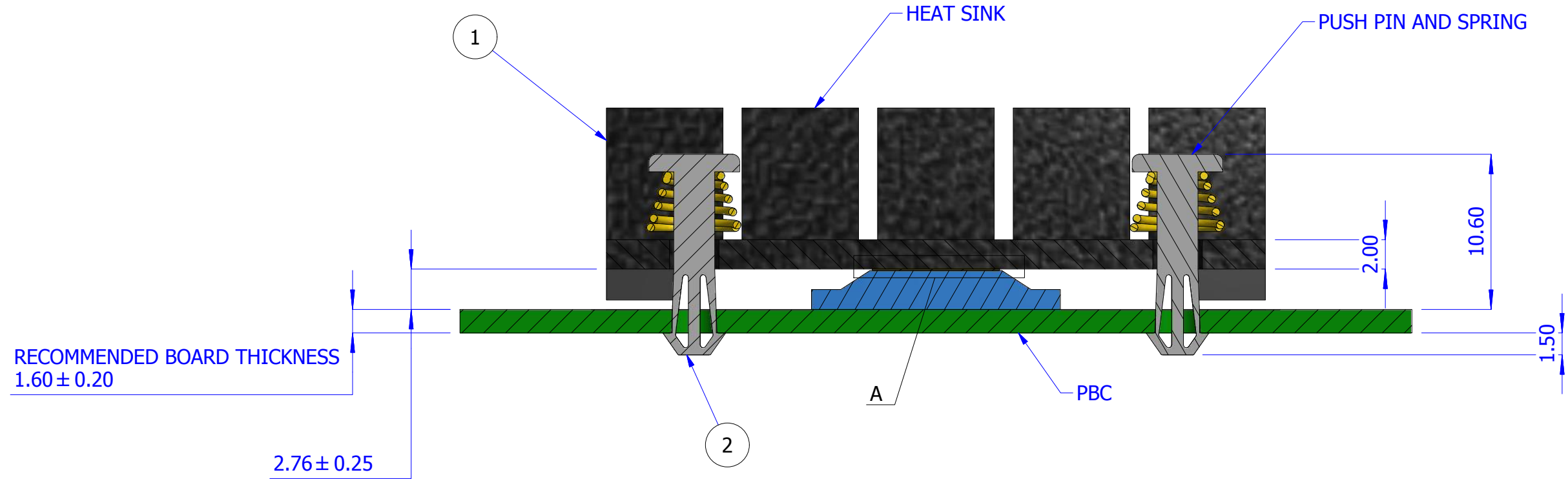

DETAIL A



3
THERMALLY CONDUCTIVE GREASE: THERMAL GREASE
SHIN-ETSU CHEMICAL CO.LTD 0.1mm THIK
P/N X-23-7783D IS PART OF HEAT SINK

UNLESS OTHERWISE SPECIFIED DIMENSIONS ARE IN MM		Mellanox Technologies Ltd. P.O.B. 586 Yokneam Zip : 20692 - Israel Tel : 972-4-9097200			
USE DIMENSIONS ONLY DO NOT SCALE		TITLE Heat sink for ConnectX®-3 Pro with thermal grease with 2 push-pins		REV 00	
GENERAL TOLERANCE: LINEAR: ± 0.1 RADIAL: ± 0.1 ANGLES: ± 0.5° BTWN HOLE CENTERS: ± 0.1		1st ANGLE PROJECTION		SCALE A3 DRAWING / P.N. : MTMH00061	